

SECTION AV-AV

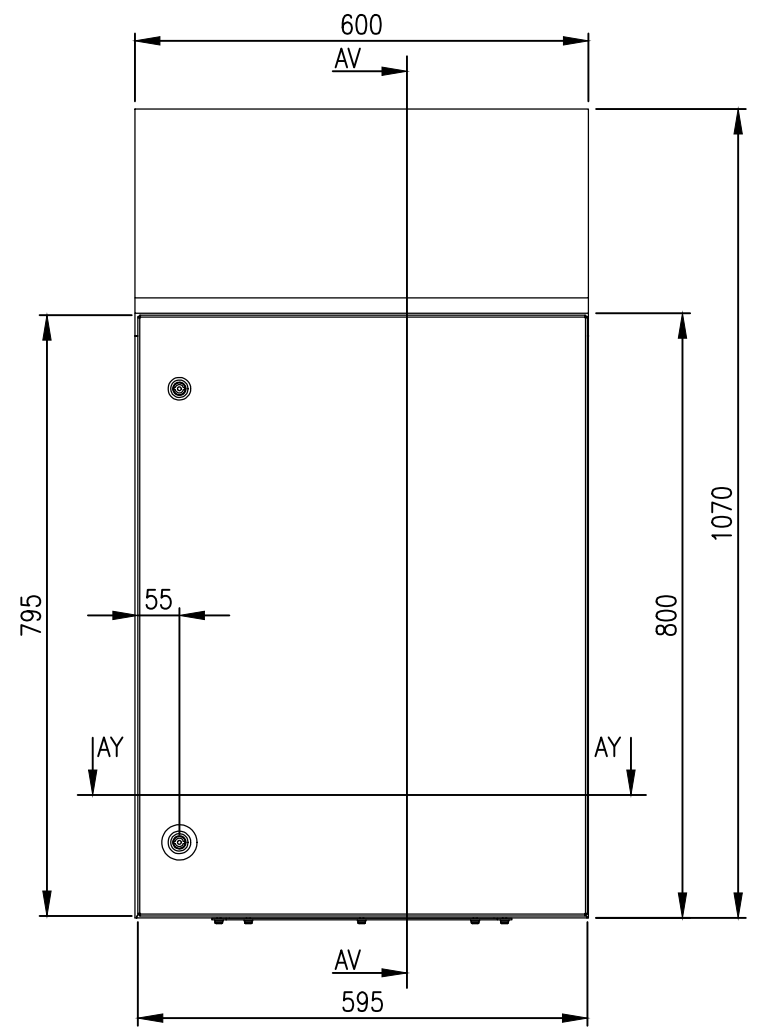

FRONT VIEW

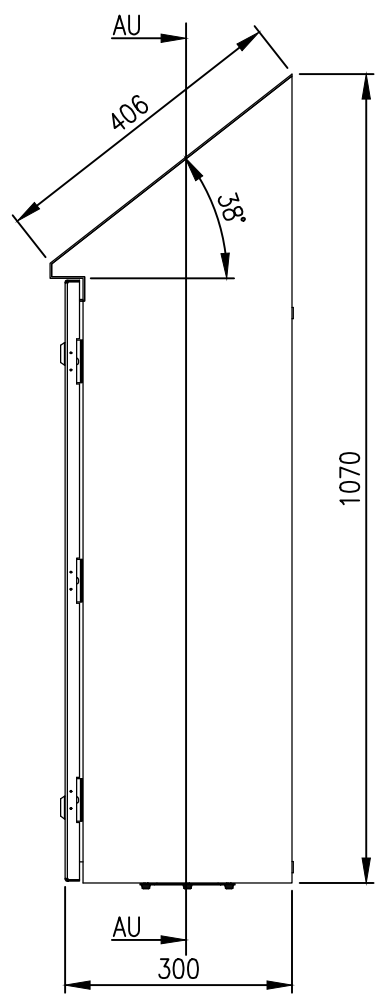

RIGHT SIDE VIEW

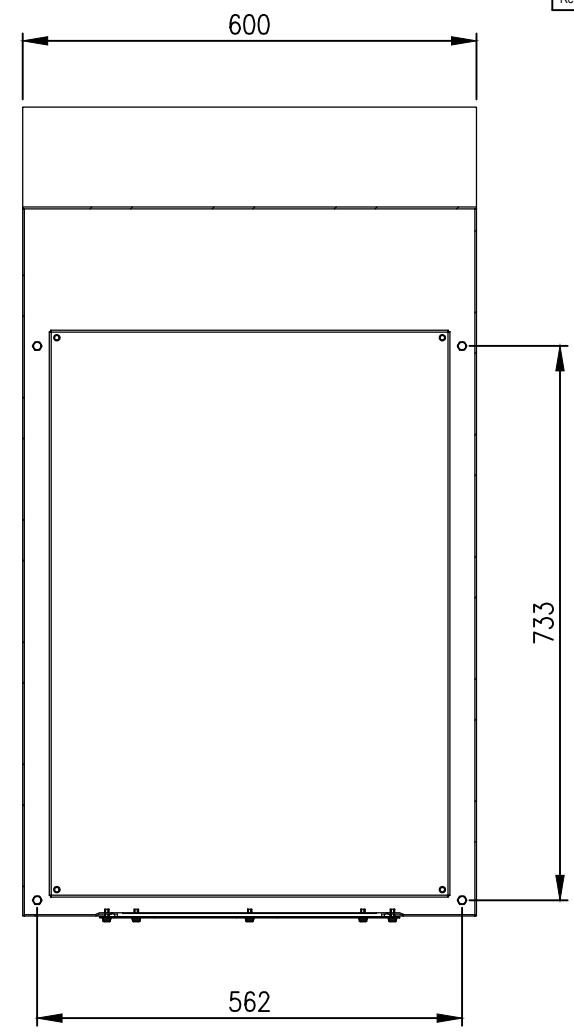

SECTION AU-AU

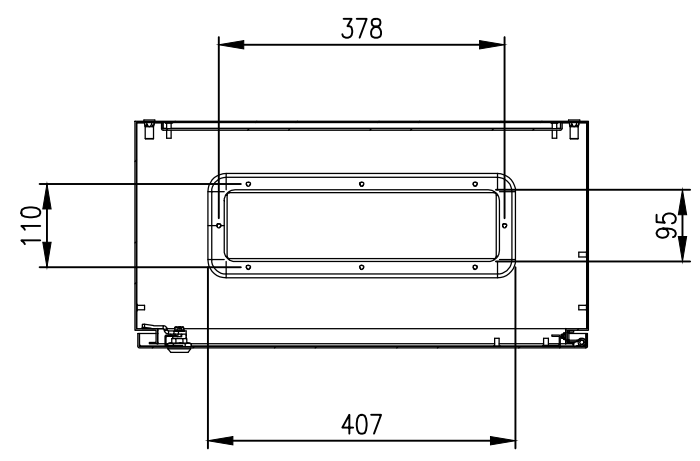
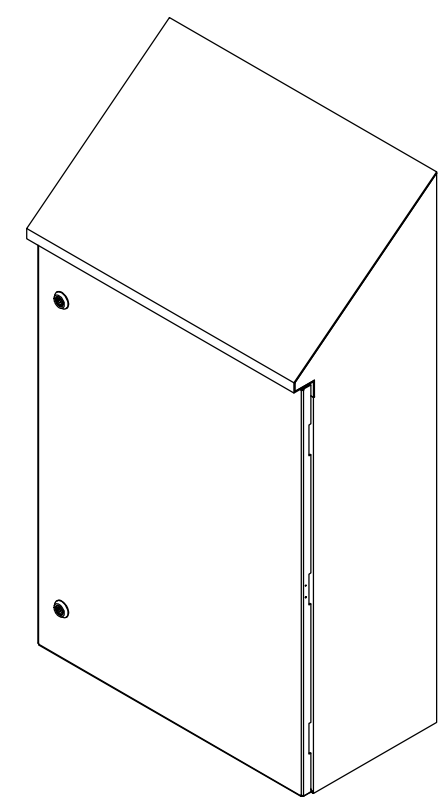

SECTION AY-AY

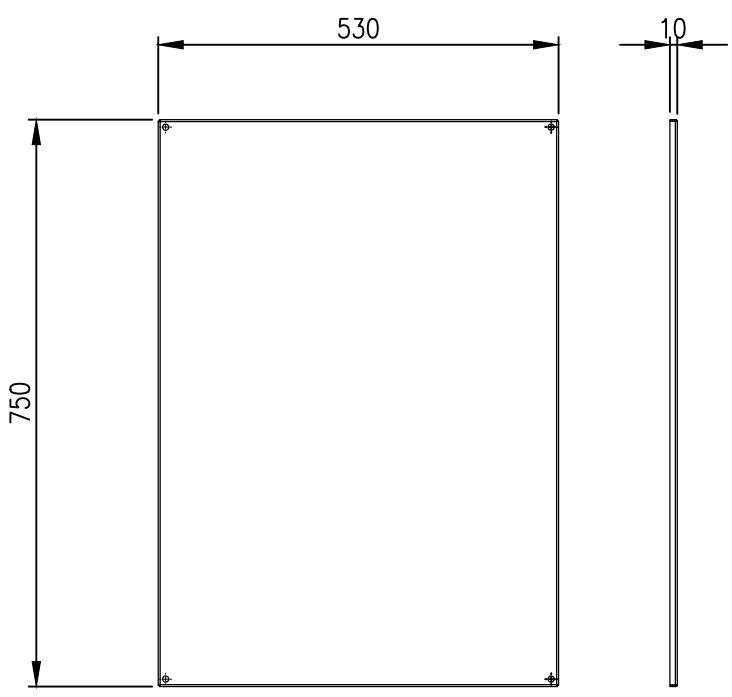

MOUNTING PLATE
(PAINTED TO RAL9010)

MATERIAL
 BODY: 2.0mm GALVANISED STEEL SHEET
 DOOR: 2.0mm GALVANISED STEEL SHEET
 MOUNTING PLATE: GALVANISED STEEL SHEET
 GLAND PLATE: 2.0mm GALVANISED STEEL SHEET
 SEAL: POLYURETHANE
 COLOUR: RAL2000 ORANGE

PROTECTION: IP66 IK10, NEMA 4
 STANDARD: IEC62208, IEC/EN/AS60529

© IP ENCLOSURES 2023.
 THIS DRAWING SHALL NOT BE COPIED OR REPRODUCED WITHOUT
 AUTHORISATION FROM IP ENCLOSURES.
 www.ipenclosures.com.au

Itemref	Quantity	Title/Name, designation, material, dimension etc	Article No./Reference
Designed by IP	Checked by IP	Approved by - date 01/02/23	Filename IP-SSR806030-HD-OR
Date 01/02/23	Scale 1:10	800x600x300 HD STEEL SLOPING ROOF ENCLOSURE	
IP-SSR806030-HD-OR		Edition 0	Sheet 1/1