

INDEX	NUMBER	DATE	VISUM	NICHT VERMASSTE RADIIEN NOT DIMENSIONED RADIUS	R5	MATERIAL	ERP NUMBER		
-	-	-	-	KANTEN GEBROCHEN SHARP EDGES REMOVED	0.2...0.4		ERP RAW NR.		
-	-	-	-	DREHMOMENT NACH TORQUE ACCORDING TO	AAW_0002	GEW./MASS 333.034 kg	UNLESS OTHERWISE SPECIFIED DIMENSIONS EXPRESSED IN METRIC		
-	-	-	-	GENERAL TOLERANCES / ALLGEMEINTOLERANZEN		FINISH ACCORDING TO AAW_0005	DRAWN	APPROVALS	DATE
-	-	-	-	ISO 2768 - m L			raja		20.06.24
-	-	-	-	WELD SYMBOLS / SCHWEISSSYMBOLS			CHECKED & RELEASED		
-	-	-	-	EN 22553					

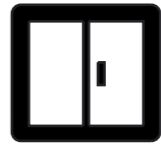

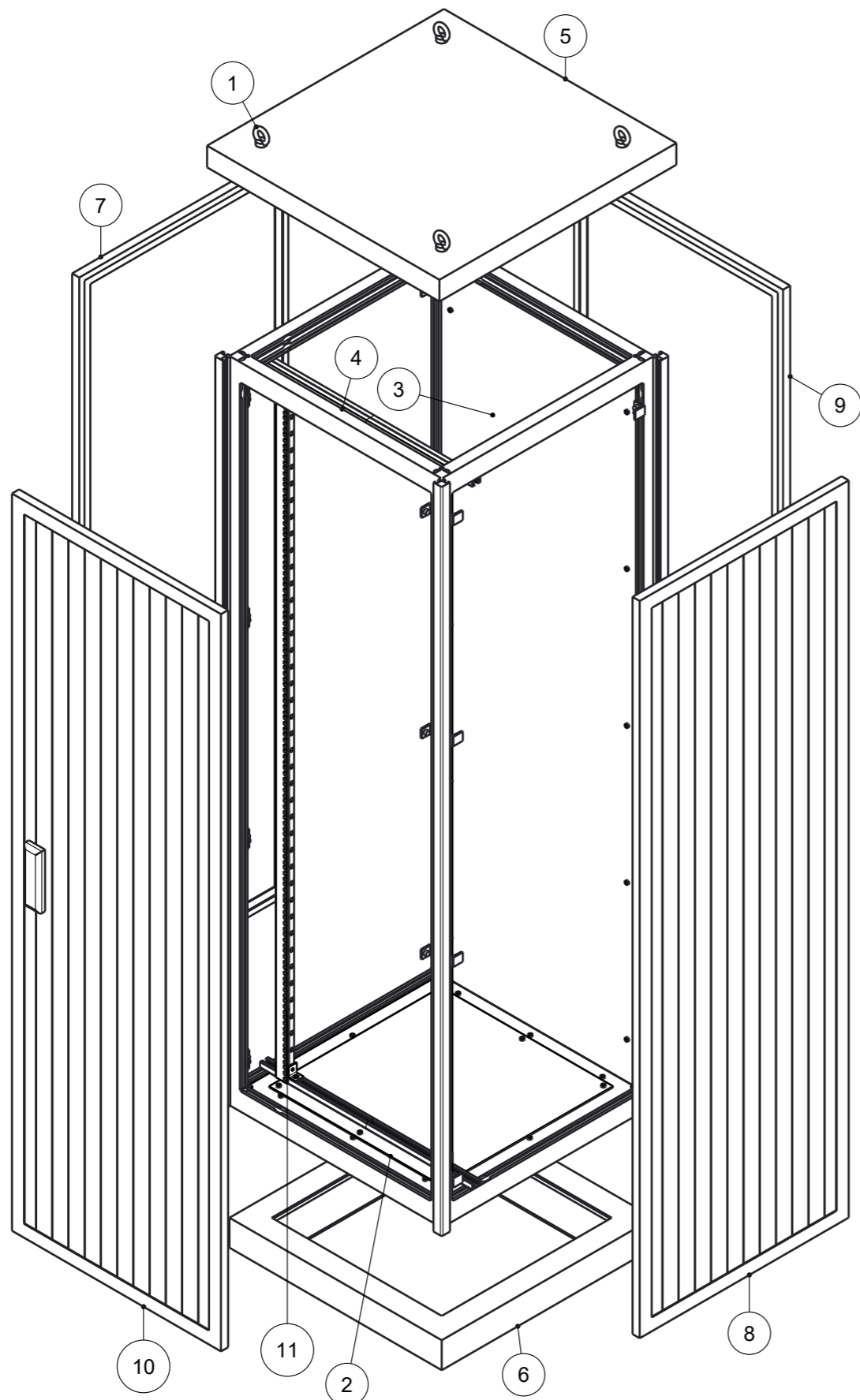

 Almtec AG Industriestrasse 12 CH-6170 Schüpfheim Switzerland	ALM-ANK2007070 2000H x 700W x 700D DOUBLE WALL ELECTRICAL CABINET	REV	-	
	SIZE A3	ALMATEC IDENT NUMBER 1585727	SHEET	-
	SCALE 1:17	RELEASE STATUS Wird bearbeitet	SHEET	1/3

THIS DRAWING AND THE DESIGN SHOWN HERE ON ARE THE EXCLUSIVE PROPERTY OF ALMATEC SWITZERLAND. ITS CONTENTS CANNOT BE COPIED, COMMUNICATED OR REPRODUCED IN ANY FORM, FOR ANY PURPOSE, WITHOUT PRIOR SPECIFIC WRITTEN CONSENT FROM ALMATEC SWITZERLAND.  
 DIESE ZEICHNUNG UND IHR INHALT STEHEN UNTER DEM ALLEINIGEN RECHT DER FIRMA ALMATEC SWITZERLAND. DIE ZEICHNUNG UND IHR INHALT DÜRFEN IN KEINER FORM KOPIERT, WEITERGEGEBEN, ODER REPRODUZIERT WERDEN, OHNE DIE SCHRIFTLICHE ZUSTIMMUNG DER FIRMA ALMATEC SWITZERLAND.

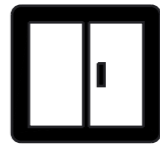

ITEM NO	Part number	QTY Stk.	Description Benennung	Weight Gewicht kg / Part
1	012877	4	Ringschraube M10	0.102
2	1585729	1	ANK Bodenblech aufgesetzt 700x700 mit Flanschplatte	3.670
3	1585734	1	ANK Montageplatte 700x2000	9.605
4	1585738	1	Dummy ANK Ständer	41.128
5	1585739	1	Dummy ANK Flachdach 58 700x700	49.354
6	1585740	1	Dummy ANK Sockel 700x80x700	7.506
7	1585741	1	Dummy ANK Seitenwand links 2000x700	54.025
8	1585742	1	Dummy ANK Seitenwand rechts 2000x700	54.025
9	1585743	1	Dummy ANK Rückwand 700x2000	54.025
10	1585744	1	Dummy ANK Türe 1-flüglig	54.447
11	1585947	1	19" Einbau	4.351

INDEX	NUMBER	DATE	VISUM	NICHT VERMASSTE RADIIEN NOT DIMENSIONED RADIUS R5	MATERIAL	ERP NUMBER	-		ALM-ANK2007070 2000H x 700W x 700D DOUBLE WALL ELECTRICAL CABINET						
-	-	-	-	KANTEN GEBROCHEN SHARP EDGES REMOVED 0.2...0.4	GEW./MASS 333.034 kg	ERP RAW NR.	-					Almatec AG Industriestrasse 12 CH-6170 Schüpfheim Switzerland	SIZE	ALMATEC IDENT NUMBER	REV
-	-	-	-	DREHMOMENT NACH TORQUE ACCORDING TO AAW_0002	FINISH ACCORDING TO AAW_0005	UNLESS OTHERWISE SPECIFIED DIMENSIONS EXPRESSED IN METRIC	DATE						A3	1585727	-
-	-	-	-	GENERAL TOLERANCES / ALLGEMEINTOLERANZEN ISO 2768 - m L	TO AAW_0005	APPROVALS	DATE	SCALE	RELEASE STATUS	SHEET					
-	-	-	-	WELD SYMBOLS / SCHWEISSYMBOLLE EN 22553		CHECKED & RELEASED	-	1:13	Wird bearbeitet	2/3					



THIS DRAWING AND THE DESIGN SHOWN HERE ON ARE THE EXCLUSIVE PROPERTY OF ALMATEC SWITZERLAND. ITS CONTENTS CANNOT BE COPIED, COMMUNICATED OR REPRODUCED IN ANY FORM, FOR ANY PURPOSE, WITHOUT PRIOR SPECIFIC WRITTEN CONSENT FROM ALMATEC SWITZERLAND.  
 DIESE ZEICHNUNG UND IHR INHALT STEHEN UNTER DEM ALLEINIGEN RECHT DER FIRMA ALMATEC SWITZERLAND. DIE ZEICHNUNG UND IHR INHALT DÜRFEN IN KEINER FORM KOPIERT, WEITERGEGEBEN, ODER REPRODUZIERT WERDEN, OHNE DIE SCHRIFTLICHE ZUSTIMMUNG DER FIRMA ALMATEC SWITZERLAND.

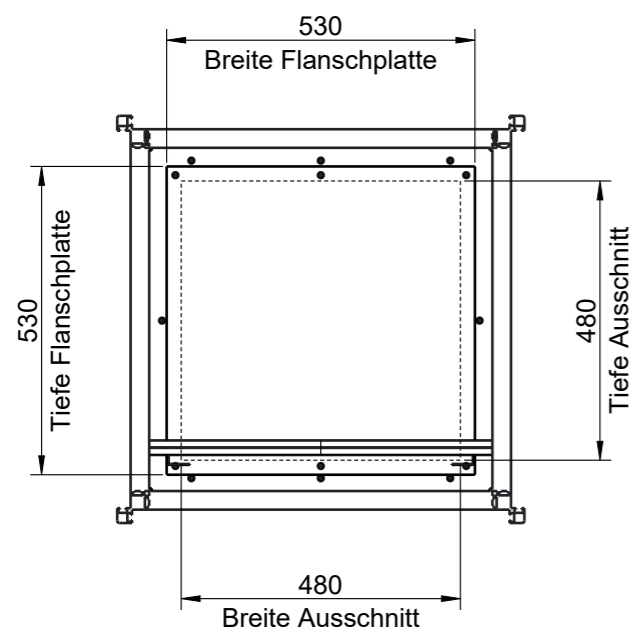
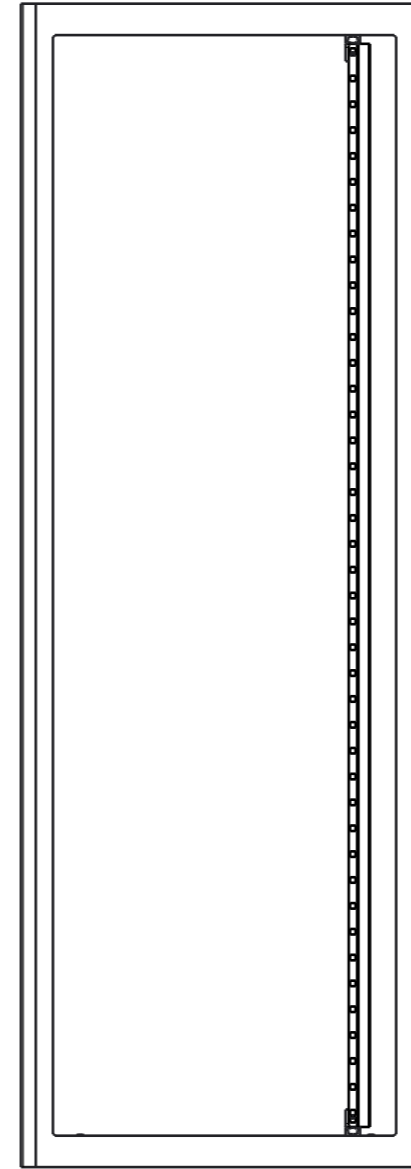
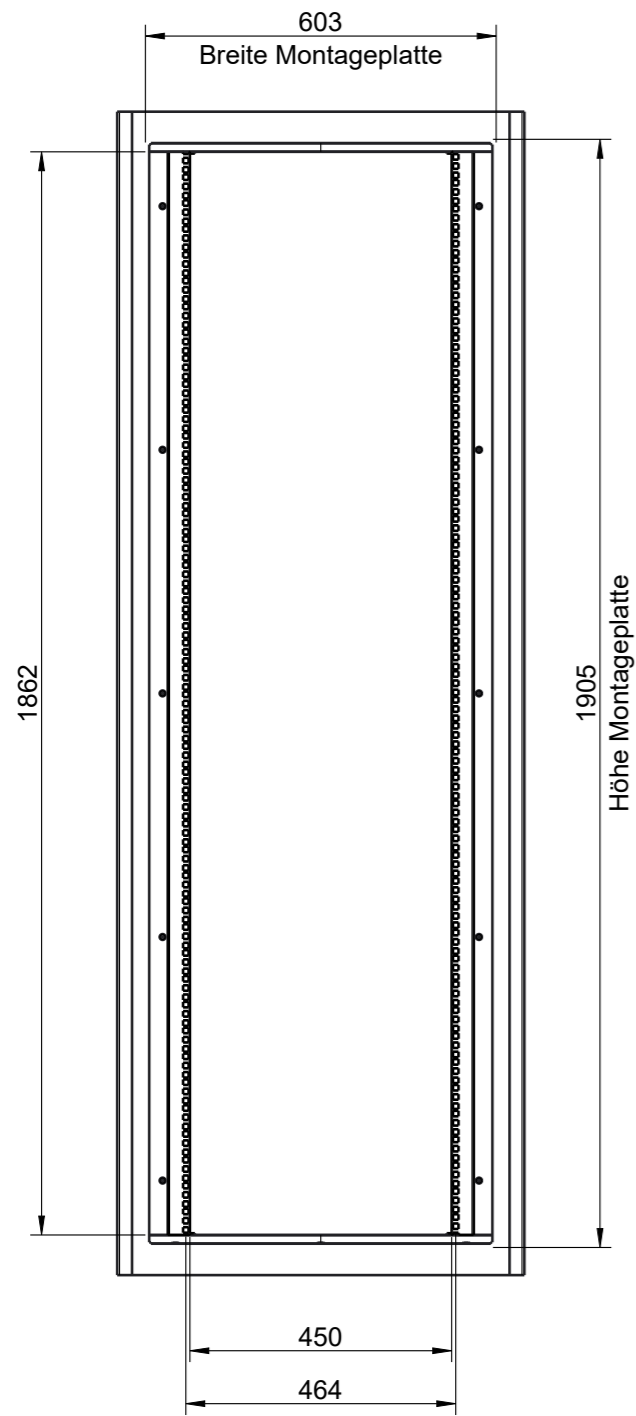

INDEX	NUMBER	DATE	VISUM	NICHT VERMASSTE RADII NOT DIMENSIONED RADIUS	R5	MATERIAL	ERP NUMBER		
-	-	-	-	KANTEN GEBROCHEN SHARP EDGES REMOVED	0.2...0.4		ERP RAW NR.		
-	-	-	-	DREHMOMENT NACH TORQUE ACCORDING TO	AAW_0002	GEW./MASS 333.034 kg	UNLESS OTHERWISE SPECIFIED DIMENSIONS EXPRESSED IN METRIC		
-	-	-	-	GENERAL TOLERANCES / ALLGEMEINTOLERANZEN		FINISH ACCORDING TO AAW_0005	DRAWN	DATE	
-	-	-	-	ISO 2768 - m L			raja	20.06.24	
-	-	-	-	WELD SYMBOLS / SCHWEISSYMBOLS			CHECKED & RELEASED		
-	-	-	-	EN 22553			-	-	

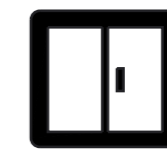

Almatec AG  
Industriestrasse 12  
CH-6170 Schüpfheim  
Switzerland

ALM-ANK2007070  
2000H x 700W x 700D  
DOUBLE WALL ELECTRICAL CABINET

SIZE	ALMATEC IDENT NUMBER	REV
A3	1585727	-
SCALE	RELEASE STATUS	SHEET
1:13	Wird bearbeitet	3/3

THIS DRAWING AND THE DESIGN SHOWN HERE ON ARE THE EXCLUSIVE PROPERTY OF ALMATEC SWITZERLAND. ITS CONTENTS CANNOT BE COPIED, COMMUNICATED OR REPRODUCED IN ANY FORM, FOR ANY PURPOSE, WITHOUT PRIOR SPECIFIC WRITTEN CONSENT FROM ALMATEC SWITZERLAND.  
DIESE ZEICHNUNG UND IHR INHALT STEHEN UNTER DEM ALLEINIGEN RECHT DER FIRMA ALMATEC SWITZERLAND. DIE ZEICHNUNG UND IHR INHALT DÜRFEN IN KEINER FORM KOPIERT, WEITERGEGEBEN, ODER REPRODUZIERT WERDEN, OHNE DIE SCHRIFTLICHE ZUSTIMMUNG DER FIRMA ALMATEC SWITZERLAND.